

**DD: 03**

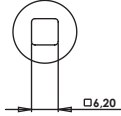

**DD: 46**

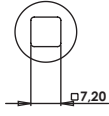

**DD: 47**

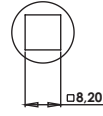

**DD: 48**

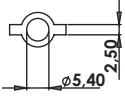

**DD: 05**



**DD: 77**

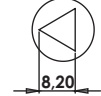

**DD: 78**

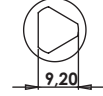

**DD: 79**

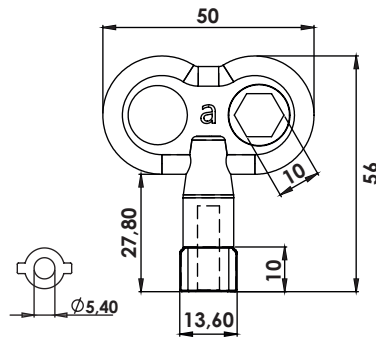
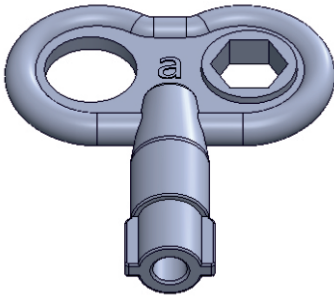
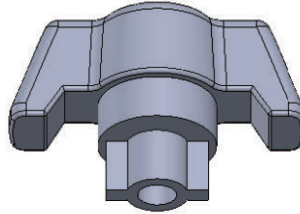
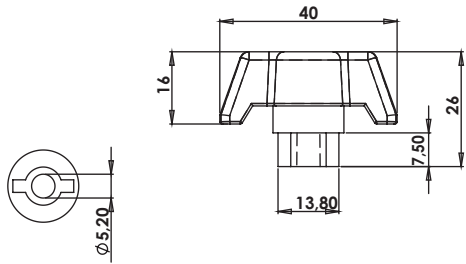

**AP01.DD.35.0**

**PLASTİK ANAHTAR (DB 5mm)  
PLASTIC KEY (DB 5mm)**



**AP02.05.35.0**

**PLASTİK ANAHTAR (DB 5mm)  
PLASTIC KEY (DB 5mm)**

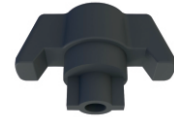

**AP04.05.35.0**

**PLASTİK ANAHTAR (DB 5mm)  
PLASTIC KEY (DB 5mm)**



**Malzeme :**

\* Polyamide DIN-EN ISO 1043-1 PA6 GFR30

**Material :**

\* Polyamide DIN-EN ISO 1043-1 PA6 GFR30